

ULTRAMAC 800-4T Ultrasonic Thickness Measuring System for Plastic Pipe

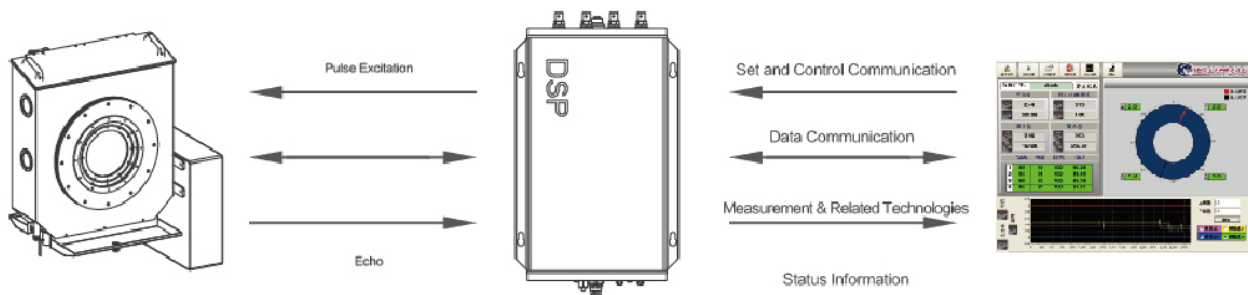

System Structure

The measurement system is formed by hardware components such as scanning box, DSP signal processor and industrial personal computer (IPC), like the following figure:



Scanning Box

DSP Processor

Man-machine interface

Scanning Box

The scanning box is equipped with ultrasonic measuring probe inside and has a probe cooling and purging device. The ultrasonic probes convert DSP signal processing pulse incentive energy into ultrasonic wave and send it out, and convert echo small signals into weak electricity signals and send it back to the DSP signal processor.

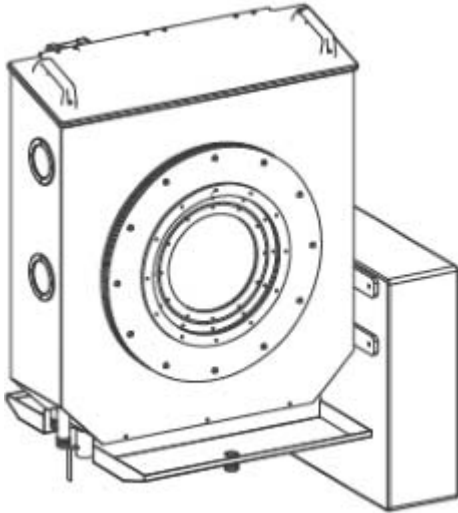

The Measurement Principle of Probe is as Follows:

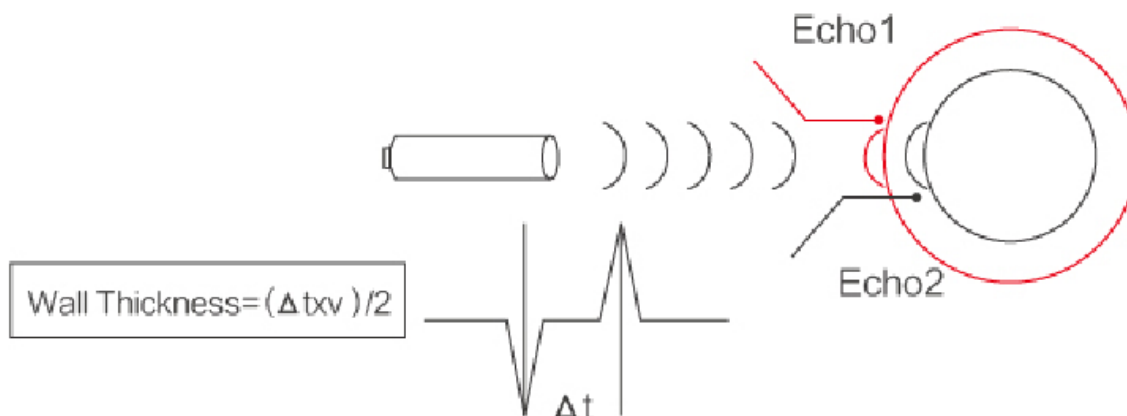

Δt = The interval time between the two waves

v = The acoustic wave speed in the material

Ultrasonic Probe Distribution Structure, As Shown:

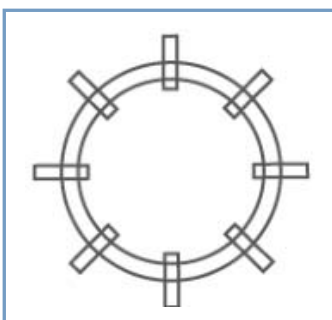

1. The built-in fixed ultrasonic transmitter can measure various range of pipe wall Thickness.
2. The number of ultrasonic probe: 4、 8、 16.
3. The ultrasonic probe is IP68 protection grade ultrasonic probes can be directly fixed in the scanning box.
4. It can be used for multi-layer pipes thickness measuring with separately display of each layer (optional).



Man-Machine Interaction (MMI)-Display Control Hardware and Software:

The Datase-15H industrial tablet computer with DATASE1000R ultrasonic measurement control software is configured , which is used as the tool of data interchange , data acquisition and data storage . It use the high-end 12 or 15-inch TFT color touch LCD screen. The whole machine adopts the ultra-thin and fanless structure , with light weight and good heat dissipation, therefore , it can be used in a continuous operation environment with dusty, high electro-magnetic interference and high ambient temperature, The system has a large-capacity hard disk which can store production data for a long time.

Technical Parameter

Model	Configuration
US1012	4 probes, the OD Measuring range:0.25-12mm
US1024	4 probes ,the OD Measuring range:3.75-24mm
ULTRAMAC 032-4T	4 probes, the OD Measuring range:3.75-32mm
ULTRAMAC 063-4T	4 probes, the OD Measuring range:3.75-63mm
ULTRAMAC 063-4T/2	4 probes, the OD Measuring range:20-125mm
ULTRAMAC 125-4T	4 probes, the OD Measuring range:20-125mm
ULTRAMAC 160-4T	4 probes, the OD Measuring range: 32-160mm
ULTRAMAC 160-8T	4 probes, the OD Measuring range:32-160mm
ULTRAMAC 250-4T	4 probes, the OD Measuring range: 90-250mm
ULTRAMAC 250-8T	4 probes, the OD Measuring range:90-250mm
ULTRAMAC 315-4T	4 probes, the OD Measuring range: 110-315mm
ULTRAMAC 315-8T	4 probes, the OD Measuring range:110-315mm
ULTRAMAC 450-4T	4 probes, the OD Measuring range:160-450mm
ULTRAMAC 450-8T	4 probes, the OD Measuring range: 160-450mm
ULTRAMAC 630-4T	4 probes, the OD Measuring range: 250-630mm
ULTRAMAC 630-8T	4 probes, the OD Measuring range:250-630mm
ULTRAMAC 800-4T	4 probes, the OD Measuring range:315-800mm
ULTRAMAC 800-8T	4 probes, the OD Measuring range:315-800mm
ULTRAMAC 1000-4T	4 probes, the OD Measuring range:560-1000mm
ULTRAMAC 1000-8T	4 probes, the OD Measuring range:560-1000mm
ULTRAMAC 1200-4T	4 probes, the OD Measuring range: 800-1200mm
ULTRAMAC 1200-8T	4 probes, the OD Measuring range: 800-1200mm
ULTRAMAC 1600-4T	4 probes, the OD Measuring range: 800-1600mm
ULTRAMAC 1600-8T	4 probes, the OD Measuring range: 800-1600mm

Note: The model and size may be changed without giving notice.